

compression cam latch

C3-1540



RL

IP65

S
SERIES

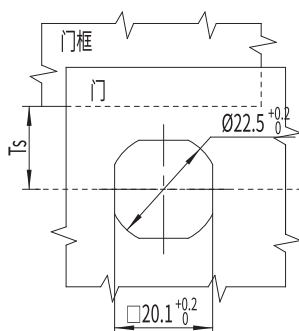
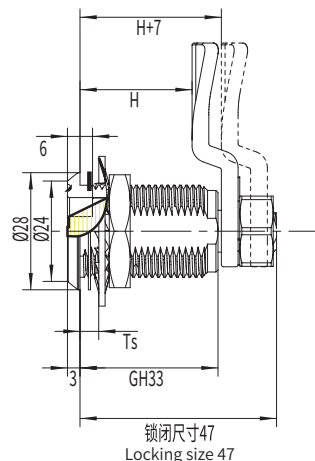
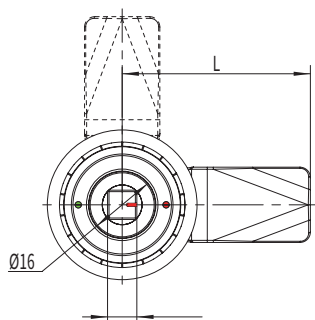

锁芯 Cylinder



选型 Model selection

锁芯选型
Lock cylinder selection

C3-1540-SX-LH-A1L

L 代表左锁 顺时针旋转锁紧
L represents clockwise rotation and locking of the left lock
R 代表右锁 逆时针旋转锁紧
R represents the counterclockwise rotation and locking of the right lock

L 代表钢栓长度
L represents the length of the steel bolt
H 代表有效高度
H represents effective height

旋转 Rotate



如需获得产品3D模型图，请联系 WWW.FORND.COM

1. Material and surface treatment:
Main body, Steel bolt: SUS304 or SUS316
Sealing ring: EPDM foam.

2. Performance parameters:
Protection class: IP65
Unlocking torque: $\leq 0.79\text{N}\cdot\text{M}$
Ultimate load: 700N
Tensioning and stretching amount: 7mm

3. Installation instructions:
Fixed screw torque 10N. M
Fixed nut torque 17N. M
Applicable door panel thickness: 1-15mm

1. 材质及表面处理:
主体, 钢栓: SUS304 或 SUS316
密封圈: EPDM发泡胶。

2. 性能参数:
防护等级: IP65
解锁扭矩: 小于等于 0.79N·M
极限载荷: 700N
拉紧伸缩量: 7mm

3. 安装说明:
固定螺丝扭矩 10N.M
固定螺母扭矩 17N.M
适用门板厚度: 1-15mm